

60" PLOW FLAP KIT

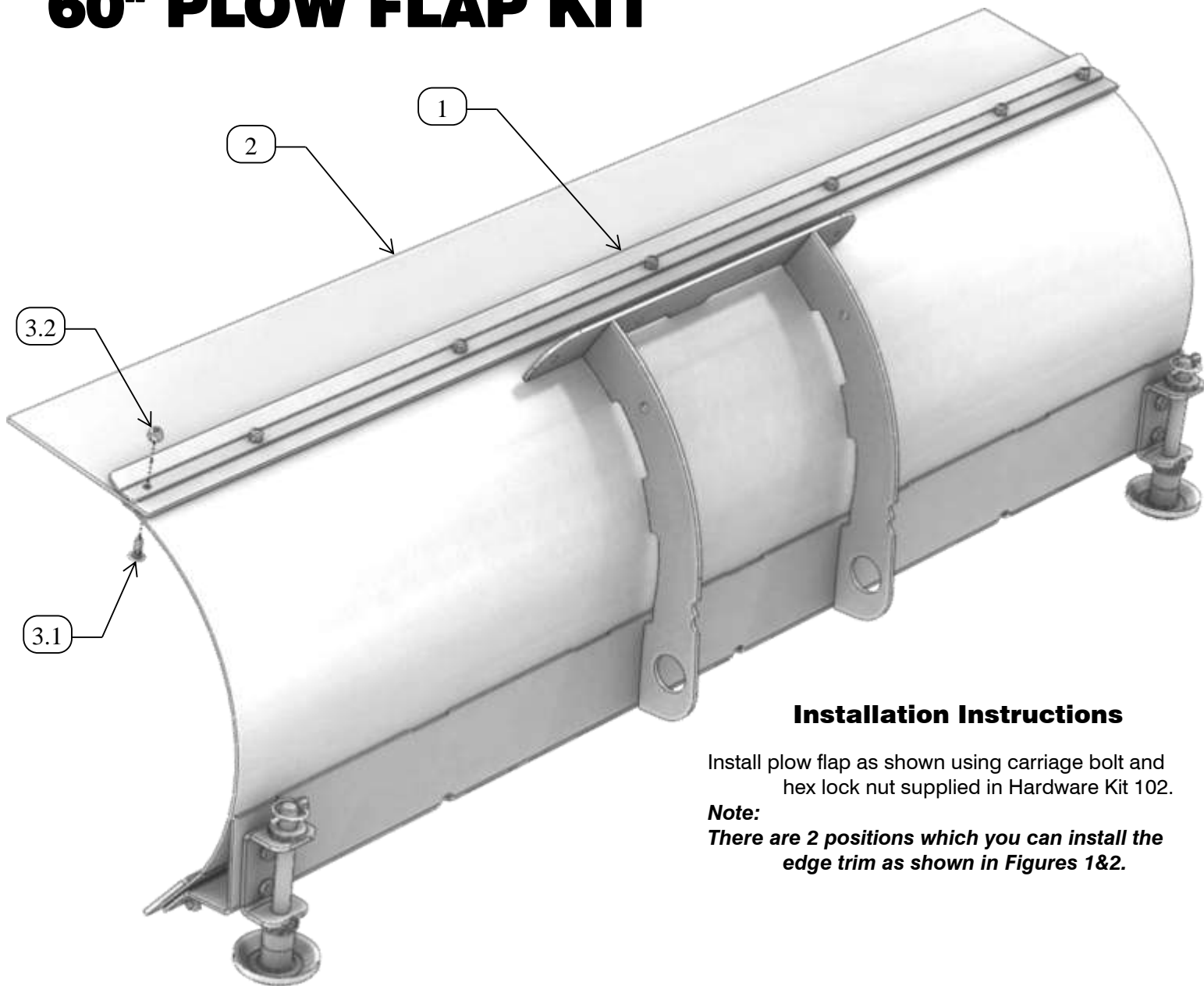

Installation Instructions

Install plow flap as shown using carriage bolt and hex lock nut supplied in Hardware Kit 102.

Note:
There are 2 positions which you can install the edge trim as shown in Figures 1&2.

105144-B PARTS LIST

ITEM #	PART #	DESCRIPTION	QTY.
1	105012	STR PLOW 60 EDGE TRIM	1
2	105147	60 RUBBER FLAP	1
3	HK-102	PLOW FLAP HARDWARE KIT	1
3.1	CB-5Z-025-20-100	1/4-20 x 1 CARRIAGE BOLT	7
3.2	HNN-5Z-025-20	1/4-20 HEX NUT NYLOCK	7

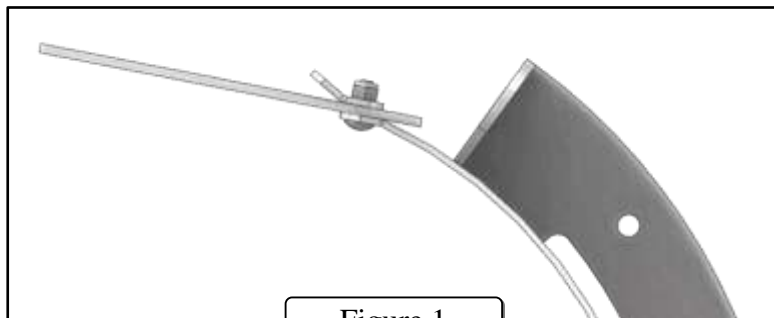

Figure 1



Figure 2