

54" PLOW FLAP

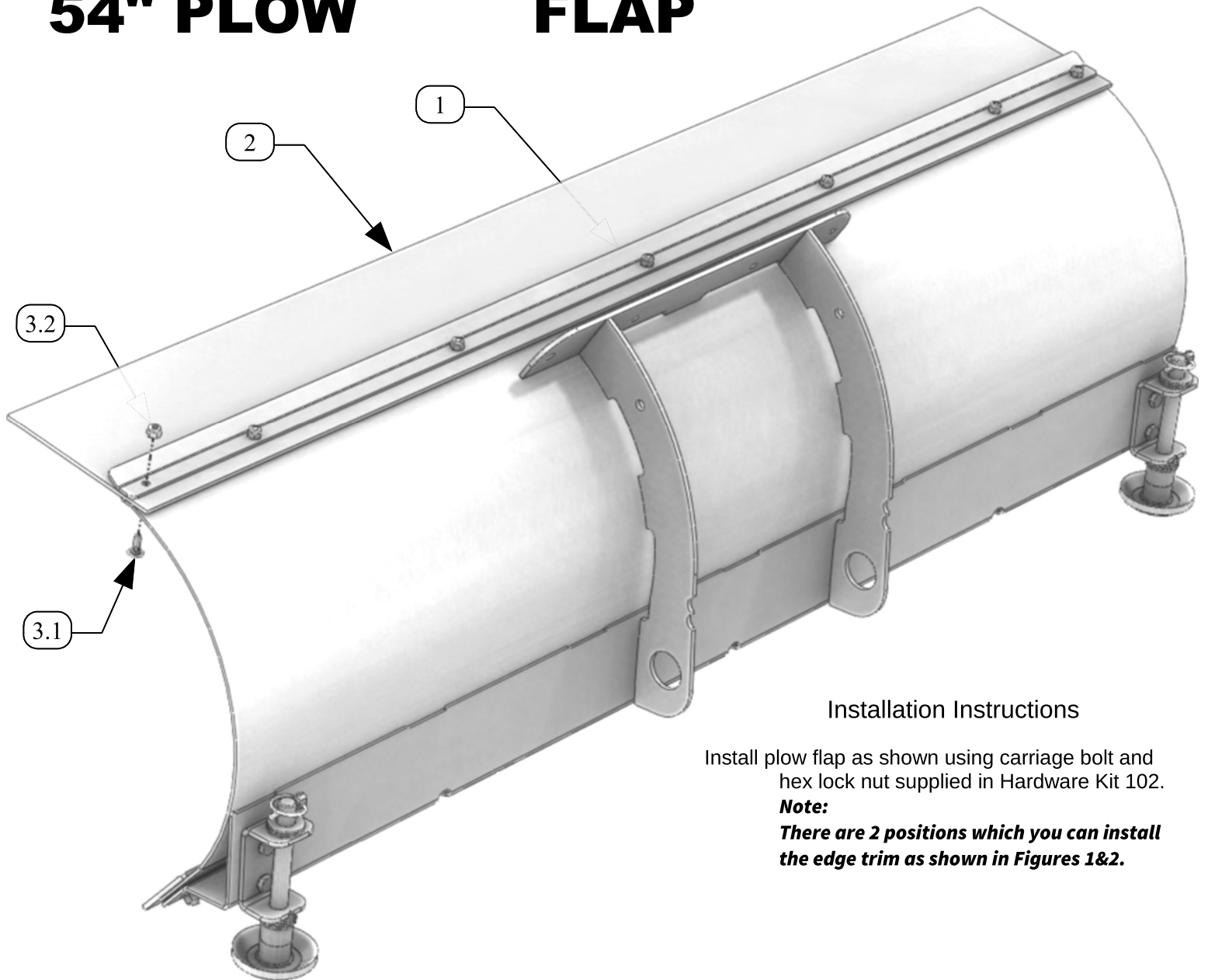

Installation Instructions

Install plow flap as shown using carriage bolt and hex lock nut supplied in Hardware Kit 102.

Note:
There are 2 positions which you can install the edge trim as shown in Figures 1&2.

105845 PARTS LIST

ITEM #	PART #	DESCRIPTION	QTY.
1	105011	STR PLOW 54 EDGE TRIM	1
2	105169	54 RUBBER FLAP	1
3	HK-102	PLOW FLAP HARDWARE KIT	1
3.1	CB-ZP-0250-20-0_75	1/4-20 x 3/4 CARRIAGE BOLT	7
3.2	HNNL-ZP-0250-20	1/4-20 HEX NUT NYLOCK	7

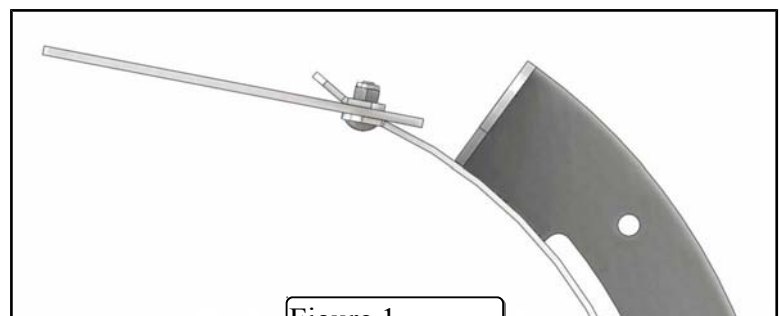

Figure 1



Figure 2