

MAHINDRA ROXOR

Winch Mount

PART # 101865

Kit Components:

Item #	Qty.	Description
1	1	Winch Mount
2	1	Wide Fairlead Adapter
3	1	Standard Fairlead Adapter
4	1	HK-192
4.1	4	1/2"-13 x 1.50 Hex Flange Bolt GR5
4.2	4	1/2"-13 Hex Flange Nut GR5
4.3	2	3/8"-16 x 1.00 Hex Flange Bolt GR5
4.4	2	3/8"-16 Hex Flange Nut GR5
4.4	1	1-3/4" ID Rubber Grommet

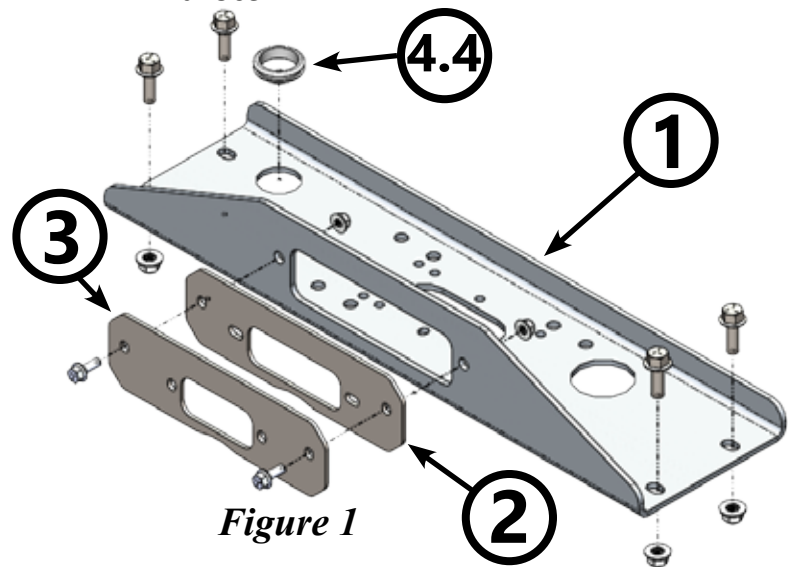

Figure 1

INSTALLATION INSTRUCTIONS:

Note: Make sure all of the hardware needed to complete this mount is in the package. Read through and understand the instructions before installing.

1. Install 1-3/4" ID rubber grommet (4.4) as shown in **Figure 1**.
2. Temporarily remove 8 bolts (A) shown in **Figure 2** and set front bumper aside to reinstall in a later step.
3. Once front bumper is removed, install winch mount (1) onto the front frame rail using the four bolt holes labeled (B) shown in **Figure 3**. Fasten winch mount (1) down using 4x 1/2" Bolts (4.1) and 1/2" Nut (4.2) as shown in **Figure 4**. **NOTE:** To install bolts, place 1/2" Nut (4.2) into 18mm wrench as shown in **Figure 4** and hold under bolt hole inside of the frame tube. Tighten down all hardware before re-installing front bumper.
4. Set front bumper (removed from Step 2) in place and install with bumper bolts (A) previously removed in Step 2 as shown in **Figure 2**.
5. Tighten all hardware evenly
6. Using the instructions provided with your winch, wire accordingly.

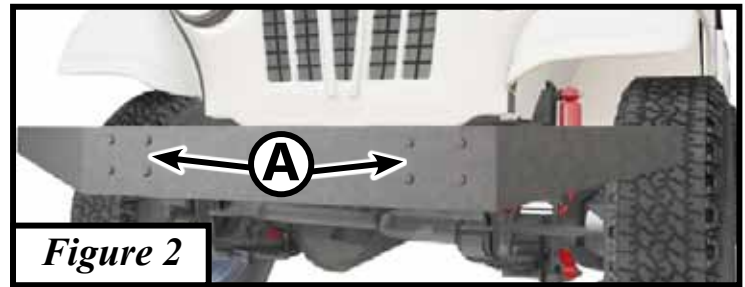

Figure 2

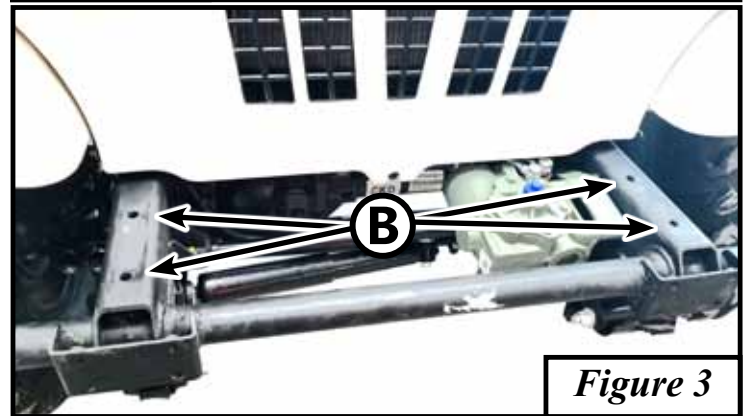

Figure 3

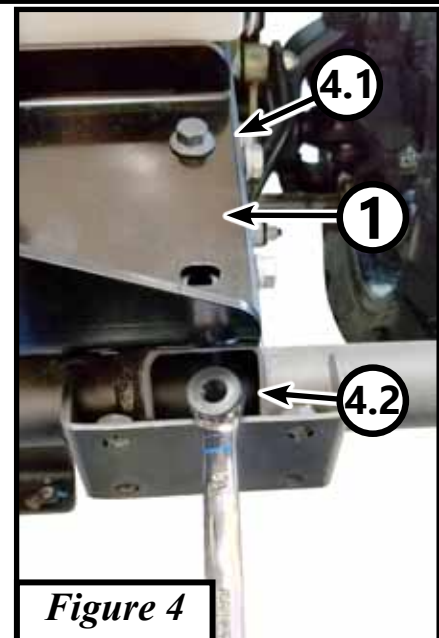

Figure 4



FAIRLEAD BRACKET INSTALLATION INSTRUCTIONS

1. **Truck Winch:** With bolt pattern of 4.5" x 6.5" or 4.5" x 10" you will discard fairlead bracket (2 & 3) and mount the fairlead directly to winch mount (1).
2. **Wide Winch:** With bolt pattern of 3" x 6.6" you will use fairlead bracket (2) and assemble per *Figure 5*.
3. **Standard Winch:** With bolt pattern of 3" x 4.875" you will use fairlead bracket (3) and assemble per *Figure 5*.

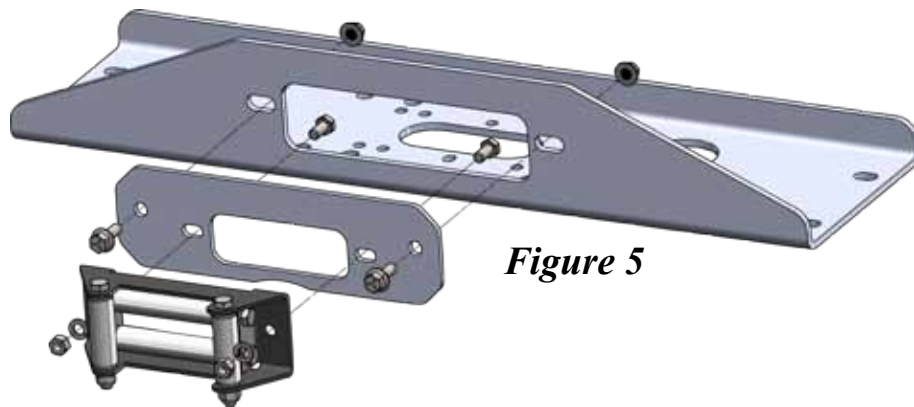

Figure 5

